

For Product Step File or 3D Model Send a Request Mail To info@nrack.com

**Pad Lockable Lock Available on Request**



**NEW**

Photo View



MS 832-1-3BG

MS 832-1-2B

CUT OUT

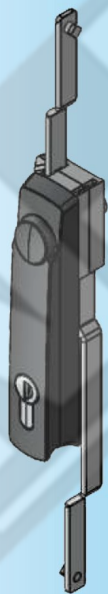
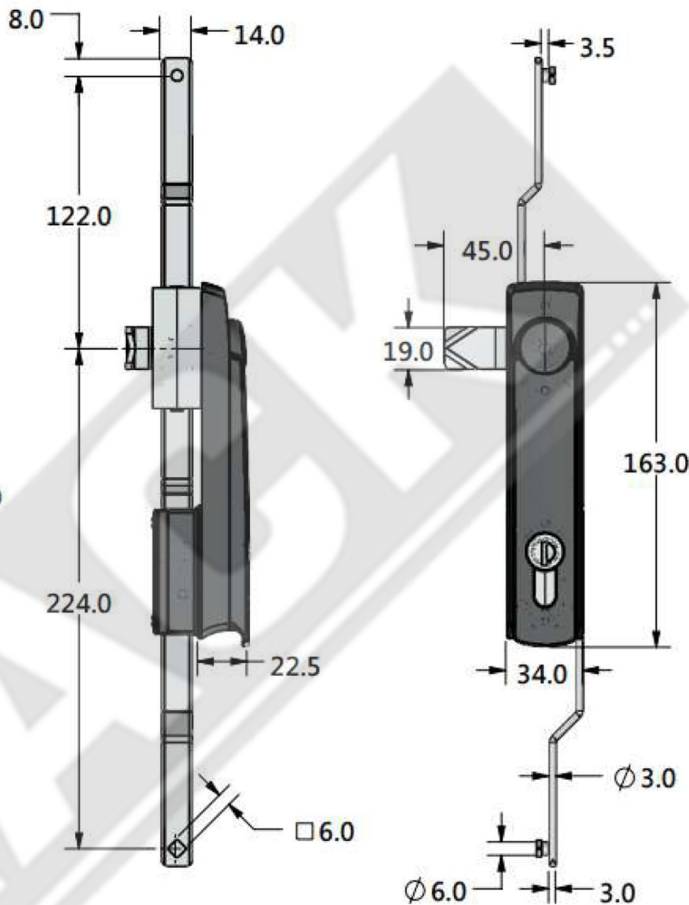
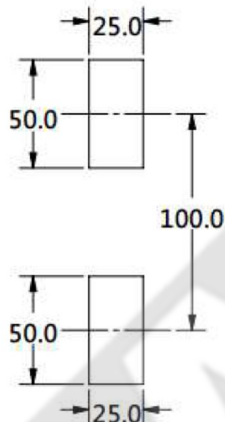

3D Rendered View

**MS 832 - 1**

- Material: PA Body housing, Zinc alloy handle zinc plating cam, Sand bright chrome plating rack
- Panel thickness: 1~2mm
- Finish: Matt black
- Remark: cam cutout □8 × 8

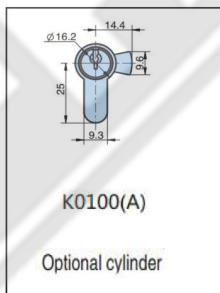

Key Insert

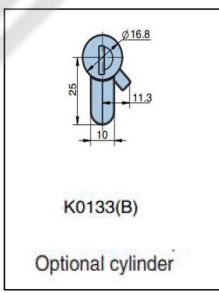

Key Insert

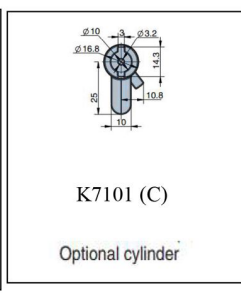

Double Bit Insert

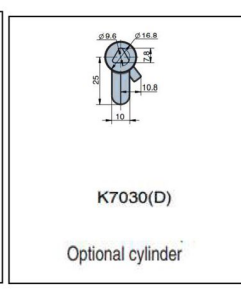

Triangular Bit Insert

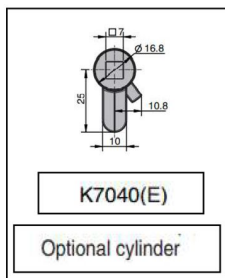

Square Bit Insert